

V.S. Portnov<sup>1</sup>, N.V. Reva<sup>2</sup>, V.I. Onishchuk<sup>2</sup>, E.S. Li<sup>1</sup><sup>1</sup>Karaganda State Technical University, Kazakhstan;<sup>2</sup>Taras Shevchenko National University of Kyiv, Ukraine

(E-mail: li\_elen.kstu@mail.ru)

## Integral characteristics of induction loop located overthin conducting layer

In the general form, the integral principle of electromagnetic soundings was developed, based on an analysis of generalized regularities of electromagnetic fields in the Earth, as spatial electric circuits. The mentioned approach determines the basic contours of a possible new direction in the development of applied electrometry. The problem of the dynamic interaction of an ungrounded loop, that is powered by a harmonic current, with a thin conducting bed, was solved. Analytic relationships that describe the dynamic increments of the active resistance and loop inductance as a function of frequency were obtained as a result of solving this problem. The asymptotic analysis of the obtained relations in the intervals of asymptotically low and high frequencies was performed, and on the basis of received results algorithms for interpreting the experimental frequency dependences of integral characteristics of the induction loop were developed. The performed fundamental developments were tested on experimental data of laboratory measurements of the frequency dependences of the increment of the active resistance and inductance of loops located above the conducting bed and on its surface. A full confirmation of the theoretical developments and in formativeness of the integral parameters of induction loops was obtained.

*Keywords:* electrical exploration, induction loop, active resistance, inductance, longitudinal conductivity, conductive layer, magnetic flux, frequency, integrated characteristics, electromagnetic sounding.

Classical modifications of induction sounding of the Earth's subsurface [1-3] are based on the experimental studying of time and frequency characteristics of electric and magnetic field strengths of excitation sources at different points on the Earth's surface. Consequently, both in the observational system and in the physical nature of the initial information characteristics, these modifications are differential. They are completely inherited from geometric sounding at a constant current where the differential research system is the only possible, and correspond to classical principles of electrical exploration. However, in alternating electromagnetic fields studying differential characteristics of the field (force) is by no means the only way to study subsurface electrical profiles.

As a new direction in electrical exploration with alternating currents, it is proposed to use the new principle for applied electrometry is the study of the electrical properties of geoelectrical sections, called integral.

From the point of view of classical principles of electrical exploration, the «ideal» option that has a maximum information content of electromagnetic sounding would be achieved if it were possible to observe simultaneously two horizontal components of the electric field ( $E_x, E_y$ ) and three components of the magnetic field ( $H_x, H_y, H_z$ ) on a set of points on the Earth's surface in the vicinity of the excitation source. Since it is technically difficult to implement such observations (it is practically impossible), we can confine to their cumulative result that is defined as the flow of electromagnetic energy through the surface of a spatial conductor. Mathematically such a problem is reduced to determining the stream of the Poynting vector

$$(\vec{P} = \int_s [\vec{E} \times \vec{H}] dS).$$

According to the well-known Umov-Poynting theorem [4, 5], the energy flux, for the case of a quasi-stationary approximation, increases with increasing current in the source on the increase in the energy of the magnetic field and on the Joule losses in the conducting medium. As the current in the source decreases, a part of energy of the magnetic field, with the exception of the necessary Joule losses, returns back to the source. Naturally, the Joule loss in the earth has the greatest dependence on the structure of the subsurface electric profile, and their dynamic dependence on the rate of changing the field can be accepted as an information parameter. Experimental determining of this parameter can be carried out in a rather simple way, in particular, by studying the dynamic interaction of the source and the conducting half-space. Thus, in principle, it is possible to perform electromagnetic sounding based on an observation system that excludes special receivers. Induction loops and grounded lines can be used as field excitation sources. The method can be implemented in a harmonic mode and in a transient mode. A modification based on the use of induction loops in a harmonic mode can be called integral induction sounding.

The purpose of this article is on the basis of a rigorous solution of the electrodynamic problem of the harmonic magnetic field of a circular induction loop, located above a thin conducting layer, to consider the basic principles of integral induction sounding, to investigate their informativeness and to confirm the possibility of their practical realization by physical modeling.

### 1. Electromagnetic field of a circular loop over a thin conducting layer

A thin conducting layer is a simple model of a conducting medium, for which relatively simple solutions can be obtained. It is known from the classical theory of electrical exploration that such a model can reflect the basic anomalous regularities of electromagnetic fields caused by real subsurface electric profiles in the low-frequency range when the field extends to a considerable depth and its structure is determined mainly by the generalized parameters of the profile. Therefore, such a model is of great importance for studying the basic regularities of the method and makes it possible to obtain simple working formulas for the analysis of experimental data.

Integral characteristics of the induction loop can be simply expressed if their quasi-stationary electromagnetic field is known. Therefore we consider the problem in general.

A circular one-turn induction loop of  $r$  radius made of a thin cable of  $r_0 \ll r$  radius is located at the  $h$  height over a thin conducting layer (Fig. 1) that has a vanishingly small thickness  $\Delta h \rightarrow 0$  and longitudinal conductivity  $S = \lim_{\Delta h \rightarrow 0} (\Delta h \cdot \gamma)$  ( $\gamma$  is specific conductivity of the layer). Magnetic permeability of the layer  $\mu$  and the surrounding insulator is equal to the magnetic permeability of the vacuum:  $\mu = 4\pi \cdot 10^{-7}$  HN / m. The loop is excited by the harmonic current  $I(t) = Ie^{-i\omega t}$  ( $I$  is the amplitude value of the current,  $\omega$  is the circular excitation frequency,  $t$  is the time,  $i = \sqrt{-1}$  is the imaginary unit). The initial phase of the exciting current is selected in such a way that for  $\omega \rightarrow 0$  the direct current flows clockwise. There should be determined: the magnetic field  $\vec{H}$  at any point in space; the surface density of the induced eddy current  $\vec{i}$  at any point of the conducting layer; caused by eddy current losses frequency-dependent increments of the active resistance  $\Delta R(\omega)$  and inductance  $\Delta L(\omega)$  with respect to the steady-state mode (inserted resistance and inductance).

Because of the axial symmetry of the problem, its solution is performed in a cylindrical coordinate system  $(R, \varphi, z)$  with the origin at the center of the loop and the  $z$  axis directed vertically downward (Fig. 1). The conductive layer divides the space into two half-spaces: the upper half (1), where the source is located, and the lower half (2). The problem is solved in quasi-stationary approximation.

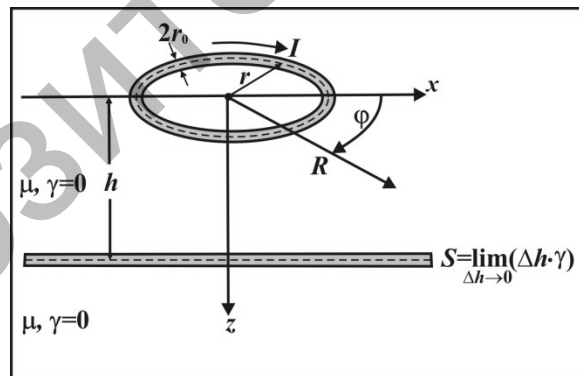

Figure 1. Induction loop over a thin layer

The resulting magnetic field  $\vec{H}$  is represented as a superposition of the frequency-independent primary field  $\vec{H}_0(R, z)$  and the frequency-dependent secondary field  $\vec{H}_a(R, z, \omega)$  of eddy currents that cause the abnormality from the conducting layer:

$$\vec{H}_0(R, z) = \vec{H}_0(R, z) + \vec{H}_a(R, z, \omega). \quad (1)$$

Quasi-stationary magnetic field in the insulator where there are no currents of conductivity is potential and can be easily determined via the scalar potential  $U$  in the expression

$$\vec{H} = -\text{grad}U. \quad (2)$$

The scalar potential of magnetic field satisfies the Laplace axisymmetric equation

$$\frac{1}{R} \frac{\partial}{\partial R} \left( R \frac{\partial U}{\partial R} \right) + \frac{\partial^2 U}{\partial z^2} = 0, \quad (3)$$

that is true for the upper and lower half-spaces ( $U_1$  and  $U_2$ ) excepting the points of the conducting layer and the cable. This equation is also satisfied by both primary and secondary and thus the resulting fields.

The problem is solved when observing certain boundary conditions on the thin conducting layer. Proceeding from the Biot-Savart's law for surface currents there is established the following boundary condition for tangential components of the magnetic field vector [4]:

$$\text{Rot} \vec{H} = [\vec{n} \times (\vec{H}_2 - \vec{H}_1)] = \vec{i}, \quad (4)$$

where  $\text{Rot} \vec{H}$  is the surface rotor of the magnetic field vector;  $\vec{n}$  is the normal ort to the layer surface;  $\vec{H}_1, \vec{H}_2$  are magnetic fields from the different sides of the conducting layer;  $\vec{i}$  in the current surface density of the conducting layer (A/m). Since in the considered case the vector of the current surface density will be presented only by the azimuth component ( $\vec{i} = i_\phi \vec{\phi}_0$ ), the scalar shape of the boundary condition (4) will have the form

$$H_R^{(2)} - H_R^{(1)} = i_\phi. \quad (4a)$$

The second boundary condition is the continuity of the normal components of the magnetic field ( $[H_z]=0$ ) upon transiting through the conducting layer, since by the condition of the problem its magnetic permeability does not differ from permeability of the surrounding medium.

The third boundary condition on the thin conducting layer is the Scheinman-Price condition [4] which is represented in the following form

$$\frac{\partial H_z^{(2)}}{\partial z} - \frac{\partial H_z^{(1)}}{\partial z} = -k_s^2 H_z^{(1,2)}, \quad (5)$$

where  $k_s = \sqrt{i\omega\mu S}$  is the wave constant of the conducting layer.

Since the considered electro-dynamic problem is solved via integrating the Laplace equation for the magnetic fields potential (3), the mentioned boundary conditions on the surface of the conducting layer can be rationally presented in the following convenient for using form

$$\left. \frac{\partial U_1}{\partial z} \right|_{z=h} = \left. \frac{\partial U_2}{\partial z} \right|_{z=h}; \quad \left. \frac{\partial^2 U_2}{\partial z^2} \right|_{z=h} - \left. \frac{\partial^2 U_1}{\partial z^2} \right|_{z=h} = -k_s^2 \left. \frac{\partial U_{1,2}}{\partial z} \right|_{z=h}; \quad i_\phi(R, \omega) = \left. \frac{\partial U_1}{\partial R} \right|_{z=h} - \left. \frac{\partial U_2}{\partial R} \right|_{z=h}. \quad (6)$$

The finiteness and continuity of the potential functions  $U_1(R, z)$  and  $U_2(R, z)$  in the entire space and their regularity in the infinity are taken as the limit conditions of the problem.

Concluding our consideration of the method for solving the problem, we point out physical simplification which is due to the adopted model of a thin conducting layer. The very formulation of such a problem neglects automatically the phenomenon of skin effect in the conducting medium and takes into account only induced currents. Therefore practical applicability of the subsequent solutions is limited to such a frequency range for which the thickness of the skin layer in the real section exceeds significantly the thickness of the conductive deposits.

Axisymmetric integrals of the Laplace equation (3) damping in the infinity, with the condition (1) taken into account, can be represented in the following form:

$$\left. \begin{aligned} U_1(R, z, \omega) &= U_0(R, z) + \int_0^\infty A(m, \omega) e^{mz} J_0(mR) dm && \text{при } z < h; \\ U_2(R, z, \omega) &= U_0(R, z) + \int_0^\infty B(m, \omega) e^{-mz} J_0(mR) dm && \text{при } z > h. \end{aligned} \right\}. \quad (7)$$

The first summands in expressions (7) represent the primary magnetic field of the loop, the second ones the field of the eddy currents induced in the conducting layer. As for the primary magnetic field, to obtain it we need to consider the solution of an individual problem which we omit in this paper but give only the final result:

$$U_0(R, z) = \mp \frac{Iq}{2} \int_0^{\infty} e^{-|mz|} J_1(mr) J_0(mR) dm, \quad (8)$$

where  $J_0, J_1$  are Bessel's functions. The “-” sign in this expression is used at  $z < 0$ , a “+” at  $z > 0$ .

In order to obtain explicit solutions, it is necessary to determine the unknown functions  $A(m, \omega)$  and  $B(m, \omega)$  that appear as a result of integrating the Laplace equation. This can be done by satisfying the first and the second boundary conditions (6), taking into account, moreover, expression (8) for the primary field. As a result we obtain integral expressions for the scalar potential of the magnetic field in an explicit form in the form of a superposition of the primary and secondary fields

$$\left. \begin{aligned} U_1(R, z, \omega) &= U_0(R, z) - \frac{Irk_s^2}{2} \int_0^{\infty} \frac{e^{-m(2h-z)}}{2m - k_s^2} J_1(mr) J_0(mR) dm \\ U_2(R, z, \omega) &= U_0(R, z) + \frac{Irk_s^2}{2} \int_0^{\infty} \frac{e^{-mz}}{2m - k_s^2} J_1(mr) J_0(mR) dm \end{aligned} \right\}. \quad (9)$$

From the result obtained it follows that in the case of high frequencies or an ideally conducting layer in the upper half-space the field is represented as a superposition of the primary field of the true source and the mirror image of the fictitious source with counter-phase excitation with respect to the plane of the layer. In the lower half-space under these conditions the primary field is completely compensated by the secondary field of eddy currents, that is the electromagnetic field does not penetrate into the lower half-space. Thus, at high frequencies the reflecting and shielding properties of the conductive layer are sufficiently expressive.

According (2), the magnetic field via the scalar potential can be determined rather easily:  $H_z = -\partial U / \partial z$ ,  $H_R = -\partial U / \partial R$ . taking into account the third boundary condition (6), it is easily to determine the surface density of the induced in the conducting layer eddy current that has only the azimuthal direction:

$$i_{\phi}(R, \omega) \Big|_{z=h} = \frac{\partial U_1}{\partial R} \Big|_{z=h} - \frac{\partial U_2}{\partial R} \Big|_{z=h} = Irk_s^2 \int_0^{\infty} \frac{me^{-mh}}{2m - k_s^2} J_1(mr) J_1(mR) dm. \quad (10)$$

The electric field on the surface of the conducting layer can be easily determined based on the Ohm's law for surface currents [4, 5]:

$$E_{\phi}(R, \omega) = \frac{1}{S} i_{\phi}(R, \omega).$$

Proceeding from the definition of the current surface density, in this simple case there can also be calculated the total force of the induced in the layer eddy current:

$$I_s(\omega) = \int_0^{\infty} i_{\phi}(R, \omega) dR = Irk_s^2 \int_0^{\infty} \frac{e^{-mh}}{2m - k_s^2} J_1(mr) dm. \quad (11)$$

The limiting case of the electromagnetic field of the induction loop is the vertical magnetic dipole field. It is easy to be obtained on the basis of expression (9) if we set infinitely small dimensions of the loop ( $r \rightarrow 0$ ) and take into account the asymptotic representation of the Bessel function for the small ( $J_1(mr) \Big|_{r \rightarrow 0} = mr/2$ ). Taking into account also the expression for the primary field (8) and performing its possible integration, for the dipole source we obtain:

$$\left. \begin{aligned} U_1^{(0)}(R, z, \omega) &= \frac{Iq}{4\pi} \left[ \frac{z}{(R^2 + z^2)^{3/2}} - k_s^2 \int_0^{\infty} \frac{e^{-m(2h-z)}}{2m - k_s^2} J_0(mR) dm \right] \\ U_2^{(0)}(R, z, \omega) &= \frac{Iq}{4\pi} \left[ \frac{z}{(R^2 + z^2)^{3/2}} + k_s^2 \int_0^{\infty} \frac{e^{-mz}}{2m - k_s^2} J_0(mR) dm \right] \end{aligned} \right\}, \quad (12)$$

where  $q = \pi r^2$  is the source area.

The integrals in (12) for the particular case where the source and the observation point are on the surface of the layer ( $h \rightarrow 0, z \rightarrow 0$ ) can be represented via modified Bessel and Struve functions. A detailed analysis of the electromagnetic field of a vertical magnetic dipole is contained in [6, 7]. Unfortunately, it is not possible to represent the integrals of expression (9) in the form of elementary or special functions. Therefore,

with the exception of asymptotic representations, the possibilities of their analytical investigation are limited only by numerical integration.

We are particularly interested in the frequency-dependent vertical component of the secondary magnetic field in the upper half-space where the source is located. Therefore, according to (2) and (9), we represent it in this form:

$$H_z^{(1)}(\omega) = -\frac{\partial U_1(\omega)}{\partial z} = \frac{Irk_s^2}{2} \int_0^\infty \frac{me^{-m(2h-z)}}{2m - k_s^2} J_1(mr) J_0(mR) dm. \quad (13)$$

Multiplying and dividing the numerator and the denominator of the integrand by the quantity conjugate to the denominator, we separate the real and imaginary parts in the considered component:

$$H_z^{(1)}(\omega) = \operatorname{Re} H_z^{(1)}(\omega) + i \operatorname{Im} H_z^{(1)}(\omega),$$

$$\operatorname{Re} H_z^{(1)}(\omega) = -\frac{Ira^2}{2} \int_0^\infty \frac{me^{-m(2h-z)}}{m^2 + a^2} J_1(mr) J_0(mR) dm,$$

$$\operatorname{Im} H_z^{(1)}(\omega) = \frac{Ira}{2} \int_0^\infty \frac{m^2 e^{-m(2h-z)}}{m^2 + a^2} J_1(mr) J_0(mR) dm, \quad (14)$$

where  $a = \omega\mu S/2$ .

Thus, in the upper half-space, due to the induced eddy currents, the real component of the vertical magnetic field is weakened, and the imaginary component is amplified. Relations (14) will then be needed as initial values for obtaining the integral characteristics of the induction loop.

## 2. Integral characteristics of the induction loop.

The induction loop, as a source of the magnetic field, has its own inductance  $L_c$  consisting of the external static inductance  $L$  and the internal inductance of the cable  $L_0$ :  $L_c = L + L_0$  from which it is made. Static and internal inductances can be estimated from the formulas known in electrical engineering:

$$L = \mu_0 r \left( \ln \frac{8r}{r_0} - 2 \right), \quad L = \frac{\mu l}{8\pi},$$

where  $\mu_0 = 4\pi \cdot 10^{-7}$  Hn/m is the vacuum magnetic permeability;  $\mu$  is the cable magnetic permeability,  $l$  its length. If the loop is multi-turn, the external inductance is determined by the linkage and the corresponding formula must be multiplied by the square of the number of turns.

Determining the integral characteristics of the induction loop is connected with calculation of the magnetic flux through its circuit. Leaving aside the primary magnetic flux that determines static inductance of the loop, as well as the internal magnetic flux determined by the internal inductance of the cable, let us study the anomalous flux of the secondary field of eddy currents. At this we use expressions (14) as the initial relations, and representation of the magnetic flux  $\Phi$  in terms of the surface integral:

$$\Phi = \int_s B_n ds = 2\pi\mu \int_0^r H_z^{(1)} \Big|_{z=0} R dR.$$

As a result for the real and imaginary components of the magnetic flux through the loop circuit we obtain the following expressions:

$$\operatorname{Re} \Phi(\omega) = -Iq\mu a^2 \int_0^\infty \frac{e^{-2mh}}{m^2 + a^2} J_1^2(mr) dm, \quad \operatorname{Im} \Phi(\omega) = Iq\mu a \int_0^\infty \frac{me^{-2mh}}{m^2 + a^2} J_1^2(mr) dm. \quad (15)$$

Thus, the secondary magnetic flux is composed of a negative real part and an imaginary positive part which is physically conditioned by the so-called «demagnetizing action of eddy currents».

Now we can calculate the integral characteristics of the induction loop. To do this we use the Ohm's law for a closed electrical circuit with successive switching active resistance  $R_a$  and inductance  $L$  which corresponds to the problem under consideration. Taking into account the time harmonic dependence of the field ( $\sim e^{-i\omega t}$ ), the Ohm's law can be represented in the following form:

$$V = I \cdot R_a + \frac{\partial \Phi_l}{\partial t} = I \cdot R_a - i\omega \Phi_l,$$

where  $I$ ,  $V$ ,  $\Phi_l$  are current, voltage values in the loop circuit and the total (primary and abnormal) magnetic flux through this circuit. Then the complex resistance  $Z$  of the induction loop considering that

$\Phi = \Phi_0 + \text{Re}\Phi(\omega) + i\text{Im}\Phi(\omega)$  where  $\Phi_0$  is the magnetic flux of the primary magnetic field, will be determined in the form:

$$Z = \frac{V}{I} = \left[ R_a + \omega \frac{\text{Im}\Phi(\omega)}{I} \right] - i\omega \left[ L + \frac{\text{Re}\Phi(\omega)}{I} \right], \quad (16)$$

where  $R_a, L = \Phi_0/I$  is static resistance and static inductance of the loop.

Thus, the secondary magnetic flux determines the frequency dependent increments of the active resistance and loop inductance (inserted resistance and inductance) which manifest themselves against the background of its static parameters. Accordingly, the equation of the induction loop, as a closed electrical circuit, can be represented in the following form:

$$Z = \frac{V}{I} = [R_a + \Delta R(\omega)] - i\omega [L + \Delta L(\omega)]. \quad (17)$$

Taking into account (15) and (16) for dynamic increments of the active resistance  $\Delta R$  and inductance  $\Delta L$  we will obtain the following expressions:

$$\Delta R(\omega) = q\omega\mu a \int_0^\infty \frac{me^{-2mh}}{m^2 + a^2} J_1^2(mr) dm; \quad \Delta L(\omega) = -q\mu a^2 \int_0^\infty \frac{e^{-2mh}}{m^2 + a^2} J_1^2(mr) dm. \quad (18)$$

If the loop is multi-turn, then the obtained formulas should be multiplied by the square of the number of turns  $n^2$  owing to the presence of mutual induction of the turns.

Thus, the increment of the active resistance  $\Delta R(\omega)$  determines eddy current losses in the conducting medium and is always positive. The increment in inductance  $\Delta L(\omega)$  reflects physically the demagnetizing effect of eddy currents and is, consequently, negative. Frequency-dependent increments of the active resistance and inductance of the field excitation source, as follows from (18), are informative parameters and, consequently, can be accepted as new for electrical exploration of integrated sources of subsurface electric profiles.

Integrals (18) cannot unfortunately be expressed in terms of elementary or known special functions. Therefore it is practically important to obtain their asymptotic representations for high and low frequencies. Carrying out an estimate of these integrals for high-frequency asymptotics of a multi-turn loop, we obtain the following formulas:

$$\begin{aligned} \Delta R(\omega)|_{\omega \rightarrow \infty} &= 2q \frac{n^2}{S} \int_0^\infty me^{-2mh} J_1^2(mr) dm = \frac{n^2}{S} f' \left( \frac{h}{r} \right); \\ \Delta L(\omega)|_{\omega \rightarrow \infty} &= -qn^2 \mu \int_0^\infty e^{-2mh} J_1^2(mr) dm = -n^2 r \mu f \left( \frac{h}{r} \right), \end{aligned} \quad (19)$$

where  $n$  is the number of turns in the induction loop.

Function  $f(k)$  is expressed via complete elliptic integrals, and function  $f'(k)$  is determined via its derivative by the loop height  $h$ :

$$\begin{aligned} f \left( \frac{h}{r} \right) &= \left[ \left( \frac{2}{k} - k \right) K(k) - \frac{2}{k} E(k) \right], \\ f' \left( \frac{h}{r} \right) &= -r \cdot \frac{\partial f}{\partial h} = k \frac{h}{r} \cdot \left[ \left( \frac{1}{1-k^2} + 1 \right) E(k) - 2K(k) \right], \end{aligned} \quad (20)$$

where  $k = r / \sqrt{r^2 + h^2}$  is the module of complete elliptic integrals of the first  $K(k)$  and the second  $E(k)$  type:

$$K(k) = \int_0^{\pi/2} \frac{d\alpha}{\sqrt{1-k^2 \sin^2 \alpha}}, \quad E(k) = \int_0^{\pi/2} \sqrt{1-k^2 \sin^2 \alpha} d\alpha.$$

The calculated plots of these functions in dependence on  $h/r$  are shown in Figure 2.

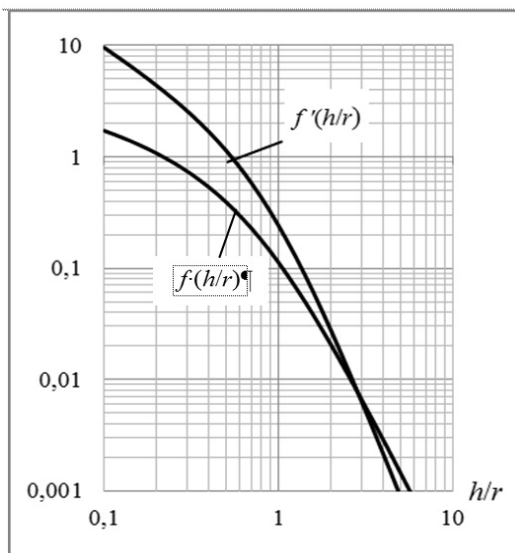

Figure 2. Plots of functions  $f(h/r)$  and  $f'(h/r)$

Thus, high-frequency asymptotics of dynamic increments of the active resistance and inductance are independent on frequency which is due to the reflective properties of the conducting layer. High-frequency asymptotics  $\Delta R(\omega \rightarrow \infty)$  can be easily determined by the longitudinal conductivity of the layer  $S$  and the height of the source rise. High-frequency asymptotics  $\Delta L(\omega \rightarrow \infty)$  depends only on the height of the source and does not depend on the longitudinal conductivity of the layer. Its physical equivalent, according to (19), is the mutual inductance of the true and mirror-like source relative to the surface of the conducting layer.

Having experimental definitions of  $\Delta R$  and  $\Delta L$  in the high-frequency range, and using the functions  $f(h/r)$  и  $f'(h/r)$  which plots shown in Figure 2, one can determine the height of the source  $h$  from the asymptote  $\Delta L$ , and the longitudinal conductivity of the layer  $S$  by the asymptote  $\Delta R$ . Therefore, for the model of the medium under consideration, the problem is solved completely and uniquely. An example of such a determination from the experimental data shown in Figure 8 is presented at the end of the paper.

For a special case, when the loop is dropped directly onto the layer ( $h=0$ ), we can obtain the following expression:

$$\Delta R(\omega) = q\omega\mu a \int_0^\infty \frac{m}{m^2 + a^2} J_1^2(mr) dm = (n^2 \pi r \omega \mu) ar I_1(ar) K_1(ar), \tag{21}$$

where  $I_1(ar)$ ,  $K_1(ar)$  are Bessel modified functions (when calculating the integral there were used references [8, 9]). The plot for the expression obtained is presented in Figure 3. In Figure 4 there is shown the nomogram  $\Delta R / (n^2 \pi r \omega \mu) = f(ar)$  that provides a correct definition of the longitudinal inductance  $S$  of the thin layer.

To obtain high-frequency asymptotics of expression (21) we use asymptotic presentations of Bessel modified functions for large values of argument:

$I_1(x)|_{x \rightarrow \infty} = e^x / \sqrt{2\pi x}$ ,  $K_1(x)|_{x \rightarrow \infty} = e^{-x} \sqrt{\pi/2x}$ . As a result we have the following simple result:

$$\Delta R(\omega)|_{\substack{h=0 \\ \omega \rightarrow \infty}} = \frac{q\omega\mu}{2r}. \tag{22}$$

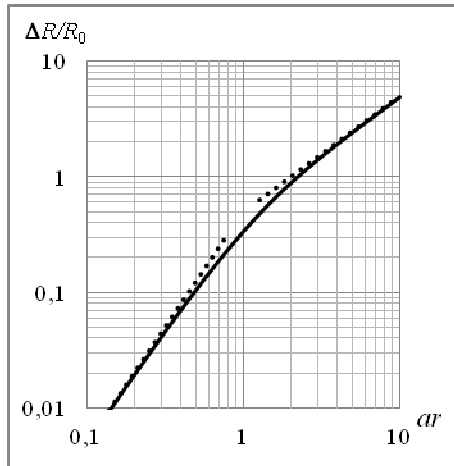

Figure 3. The induction loop active resistance increment on the thin layer dependence on the filled excitation frequency:  $R_0=2\pi n^2/S$

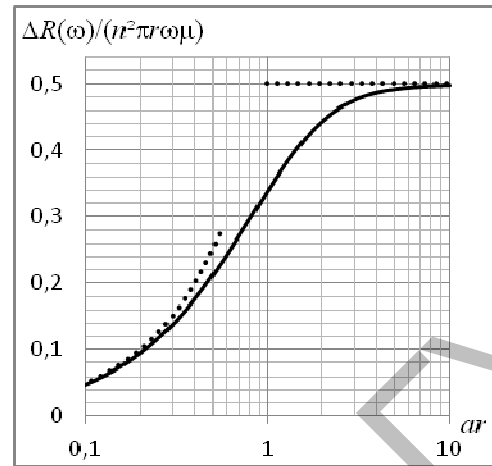

Figure 4. Normalizing function for determining the thin layer longitudinal conductivity by the induction loop active resistance increment on the layer

Relation (22) indicates that in this case high-frequency asymptotics  $\Delta R$  does not depend on the longitudinal conductivity of the layer and increases in proportion to frequency. This result is unbelievable from the physical point of view, for it is impossible to imagine an induction process in a conducting medium that is not accompanied by eddy currents losses. The considered result is obviously a purely mathematical abstraction, since with integral characteristics of the electromagnetic field it is physically unacceptable to disregard the real dimensions of the source. The introduction of at least an insignificant rise height exceeding the radius of the supply cable immediately leads to a frequency-independent asymptote  $\Delta R$  in the high-frequency region. However, this result cannot be neglected completely, since it expresses the limit mathematically possible case which determines the main regularities of the active resistance increment behavior in the high-frequency range. Its direct consequence is the shift of the frequency-independent asymptote to the region of higher frequencies with decreasing the rise height of the loop.

Now let us turn to consideration of the low-frequency asymptotics. Performing, the corresponding estimates of integrals (18), we obtain the following result:

$$\Delta R(\omega)|_{\omega \rightarrow 0} = n^2 q \frac{\omega^2 \mu^2 S}{2} \int_0^{\infty} \frac{e^{-2mh}}{m} J_1^2(mr) dm = n^2 r^2 \mu^2 \omega^2 S f_1'(h/r), \quad (23)$$

$$\Delta L(\omega)|_{\omega \rightarrow 0} = -n^2 q \frac{\omega^2 \mu^3 S^2}{4} \int_0^{\infty} \frac{e^{-2mh}}{m^2} J_1^2(mr) dm = -\frac{1}{3} n^2 r^3 \mu^3 \omega^2 S^2 f_1\left(\frac{h}{r}\right),$$

$$f_1\left(\frac{h}{r}\right) = \frac{1}{k} \left[ \left( \frac{1}{k^2} - 1 \right) K(k) - \left( \frac{1}{k^2} - 2 \right) E(k) \right] - \frac{3\pi}{4} \frac{h}{r}, \quad (24)$$

where

$$f_1'(h/r) = -\frac{1}{3} r \frac{\partial f_1}{\partial h} = \frac{h}{r} \frac{1}{k} [E(k) - K(k)] + \frac{\pi}{4}.$$

Asymptotic properties of functions  $f_1(h/r)$  and  $f_1'(h/r)$  are as follows:

$$f_1(h/r)|_{h \rightarrow 0} = 1; \quad f_1(h/r)|_{h \rightarrow \infty} = \frac{3\pi}{32} \frac{h}{r}; \quad f_1'(h/r)|_{h \rightarrow 0} = \frac{\pi}{4}; \quad f_1'(h/r)|_{h \rightarrow \infty} = \frac{\pi}{32} \frac{1}{\left(\frac{h}{r}\right)^2}. \quad (25)$$

Their plots in the functional dependence on  $h/r$  are shown in Figure 5.

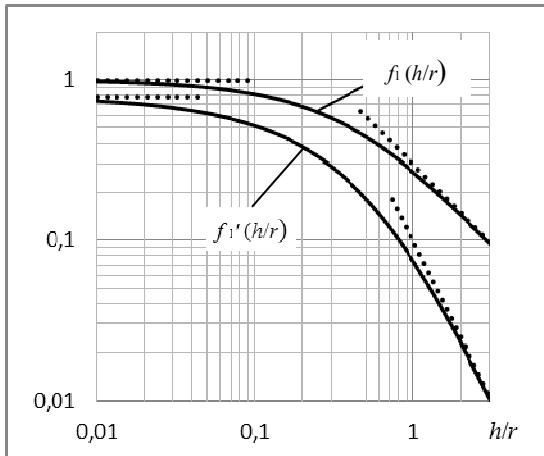

Figure 5. Plots of functions  $f_1(h/r)$  and  $f_1'(h/r)$ :  
 ..... – asymptotes

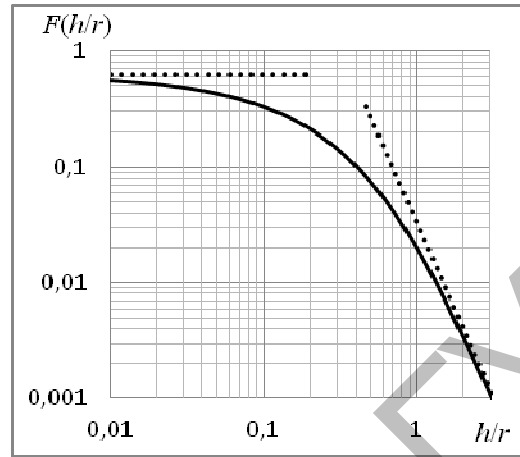

Figure 6. Plot of normalizing function for determining  $h/r$ :  
 ..... – asymptotes

Consequently, in the low-frequency range, the asymptotic values  $\Delta R(\omega)$  and  $\Delta L(\omega)$  increase in proportion to the square of the frequency  $\omega$  and depend on the longitudinal conductivity of the layer. The increased sensitivity to the longitudinal conductivity is inherent in  $\Delta L(\omega)$  as it depends on  $S^2$ . Both parameters also carry the information of the height rise  $h$  of the loop over a thin layer. Equations (23) are independent, as a result of which an unambiguous solution of the inverse problem is possible: determining  $S$  and  $h$  from the results of the experiment. At this, as the normalization function for determining the relative height  $h/r$  there can be used the following relation:

$$F\left(\frac{h}{r}\right) = \frac{[f_1'(h/r)]^2}{f_1(h/r)} = \frac{\left[\frac{h}{r} \frac{1}{k} [E(k) - K(k)] + \frac{\pi}{4}\right]^2}{\frac{1}{k} \left[ \left(\frac{1}{k^2} - 1\right) K(k) - \left(\frac{1}{k^2} - 2\right) E(k) \right] - \frac{3\pi}{4} \frac{h}{r}} \quad (25)$$

The plot of the normalizing function with its asymptotes

$$F\left(\frac{h}{r}\right) \Big|_{h \rightarrow 0} = \frac{\pi^2}{16} \quad \text{и} \quad F\left(\frac{h}{r}\right) \Big|_{h \rightarrow \infty} = \frac{\pi}{96} \left/ \left(\frac{h}{r}\right)^3 \right. \quad (26)$$

is presented in Figure 6.

Determining the information parameters  $h$  and  $S$  is practically reduced to the equation:

$$\frac{\Delta R^2}{\Delta L} \left/ (3n^2 r \mu \omega^2) = F\left(\frac{h}{r}\right) \quad (27)$$

and determining on its basis the relative height  $h/r$  with the following calculation of the longitudinal conductivity of the layer by the active resistance increment  $\Delta R$ :

$$S = \frac{\Delta R}{(n r \mu \omega)^2 f_1'(h/r)} \quad (28)$$

Having considered asymptotic representations of the integral characteristics of the induction loop located over the thin conducting layer, it is not difficult to form a qualitative representation of the overall dependence of dynamic increments of the active resistance and inductance determined by formulas (18). So, at low frequencies,  $\Delta R(\omega)$  and  $\Delta L(\omega)$  in the absolute value increase quite intensively in proportion to the square of frequency. With increasing frequency, the frequency dependence is weakened and the frequency-independent asymptote sets in at high frequencies.

The indicated regularities are confirmed by the results of physical modeling. For example, Figures 7 and 8 show the experimental curves of  $\Delta R(\omega)$  and  $\Delta L(\omega)$  as a function of frequency obtained by placing the induction loop directly on the conductive layer (Fig. 7) and over the layer at the height  $h = 7.5$  cm (Fig. 8). Parameters of the loop located on the layer: number of turns  $n = 75$ ; radius  $r = 5.3$  cm; resistance

$R = 2.435 \text{ Ohm}$ ; Inductance  $L = 1.1753 \text{ mH}$ . Parameters of the loop above the layer:  $n = 115$ ;  $r = 14.5 \text{ cm}$ ;  $R = 14.555$ ;  $L = 0.7545 \text{ mH}$ . As a conducting layer, a layer of lead 5 mm thick with longitudinal conductivity  $S = 25000 \text{ cm}$  was used.

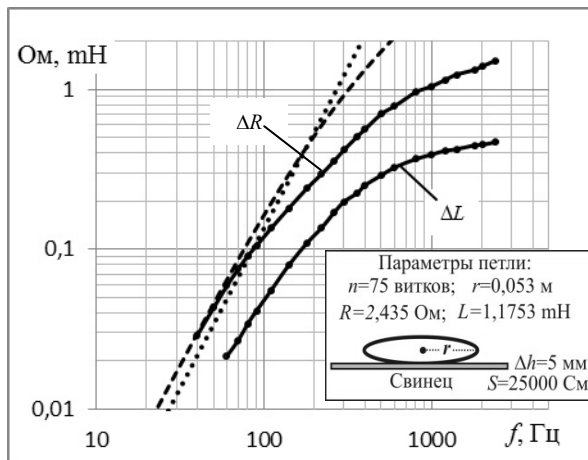

Figure 7. Experimental frequency dependences of the induction loop integral; characteristics on the conducting layer

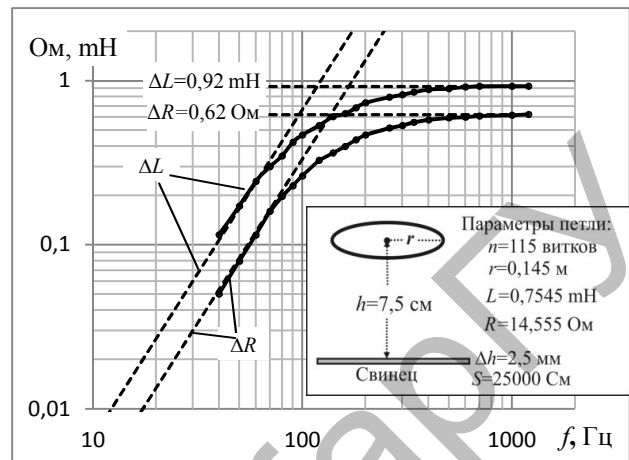

Figure 8. Experimental frequency dependences of the induction loop integral; characteristics over the conducting layer

In Figure 7, in addition to the experimental plot of dynamic increments of the active resistance, there is shown the theoretical plot of the frequency dependence of  $\Delta R(f)$  calculated by formula (21) for an ideal model of a thin conducting layer with longitudinal conductivity of 25,000 cm excited by an "ideal" induction loop ( $h=0$ ) with a radius corresponding to the experimental (dashed curve). It can be seen that in the low-frequency range the theoretical plot and the experimental result coincide completely that confirms the possibility of unambiguous determining the layer conductivity from experimental measurements of  $\Delta R(\omega)$  in the low-frequency region. Interpretation of the data in this low-frequency interval made it possible to obtain the conductivity values  $S$  within the limits of  $24000 \pm 24770 \text{ cm}$ . As the frequency is increased, the theoretical and experimental curves of  $\Delta R(f)$  become discernible which, apparently, is related to the influence of the skin effect: the physical model, in contrast to the idealized mathematical model, has a real thickness. As for the dependence  $\Delta L(\omega)$ , it seems that the low-frequency asymptote for inductance, in contrast to the active resistance, occurs in the interval of substantially lower frequencies, as is evidenced by the non-coincidence of the theoretical low-frequency asymptote calculated in accordance with formula (23) for the idealized mathematical model in which  $f_1(h/r)|_{h=0}=1$  (a dotted line). Apparently, in the low-frequency region the influence on  $\Delta L(\omega)$  of the real "effective radius"  $r_0$  of the multi-turn wire of which the loop located on the layer is made, is more significant than resistance. It goes without saying that these features of physical modeling require more careful theoretical and experimental analysis.

From considering experimental plots of frequency dependences of integral characteristics of the induction loop over the conducting layer (Fig. 8) it follows that high-frequency asymptotes  $\Delta R(\omega)$  and  $\Delta L(\omega)$  correspond completely to formulas (19). The practice of physical modeling proves also that with continuation of increasing frequency, the  $\Delta R(\omega)$  values come from the horizontal asymptote to gradual increasing that is caused by the skin-effect in real models of thin layers that is not taken into account by the idealized theoretical calculation. The high-frequency asymptote  $\Delta L(\omega)$  value made 0.92 mH, and  $\Delta R(\omega) - 0.62 \text{ Ohm}$ . Interpretation of these asymptotic data made it possible to obtain a sufficiently high-precision result: the height rise of the loop was  $h = 7.38 \text{ cm}$ , the longitudinal conductivity of the layer was  $S = 23570 \text{ cm}$ . Interpretation by low-frequency formulas eventually led to comparable data:  $h = 8.2 \text{ cm}$ ,  $S = 25000$ . In Figure 8 the dashed lines show the low-frequency asymptotes  $\Delta R(\omega)$  and  $\Delta L(\omega)$  calculated from the interpretation data. In the low-frequency range they agree well with experimental observations. Thus, the results obtained indicate a sufficiently high accuracy of experimental observations and methods of their interpretation.

### Conclusion

It is obvious that the possibilities of developing methods of applied electrometry on alternating current are far from exhausted. One of the possible trends of their further development can be considered in the article concept of using as initial information data for solving applied problem the integral characteristics of the sources of excitation of electromagnetic fields: their active resistance and inductance. The dynamic dependence of these characteristics on the rate of changing the field that reflects the dynamic interaction of the field source and the medium itself, in this case will be the information base permitting to study surface electric profiles.

The paper considers one of the electrodynamic problems aimed at studying the interaction of an inductive ungrounded loop with a thin conducting layer in order to elucidate the information possibilities of dynamic changes in active resistance and loop inductance as a source of an exciting magnetic field. As a result of the carried out analytical studies there have been obtained relations describing frequency dependences of active resistance increments and inductance of induction loops located over the thin conducting layer and directly on it. On the basis of an asymptotic analysis of dynamic changes in integral characteristics in the high and low frequencies region there have been developed the principles and algorithms for interpreting experimental data.

The results of physical modeling and their subsequent analysis on the basis of completed theoretical developments fully confirm the correctness of solutions obtained and sufficiently high information content of the integral characteristics of induction loops. The further developing and deepening of theoretical and technical studies in this trajectory can ensure developing integrated sounding methods which with significantly lower energy costs of experimental work can provide a noticeable increase in the depth of electromagnetic sounding.

### References

- 1 Вижва С.А. Электрометрия: посібник із навчальної геофізичної практики / С.А. Вижва, М.В. Рева, І.І. Онищук, В.І. Онищук. — Киев: ИПЦ «Киевский университет», 2014. — 303 с.
- 2 Кауфман А. А. Принципы методов наземной и скважинной электроразведки/ А.А. Кауфман, Б.И. Андерсон. — Тверь: Междунар. ассоциация «АИС», 2013. — 488 с.
- 3 Kamenetsky F.M. Transient Geo-Electromagnetics / F.M. Kamenetsky, E.H. Stettler, G.M. Trigubovich. – Munich: Ludwig-Maximilian-University of Munich, 2010.
- 4 Zhdanov M.S. Electromagnetic geophysics: Notes from the past and the road ahead, commercial application / M.S. Zhdanov. Geophysics. — 2010. — 75. — P. 49–66.
- 5 Светов Б.С. Основы геоэлектрики / Б.С. Светов. — М.: Изд-во ЛКИ, 2008. — 648 с.
- 6 Кузьменко Е.Д. Теория поля / Е.Д. Кузьменко, М.В. Рева. — Ивано-Франківськ: ІФНТУНГ, 2014. — 410 с.
- 7 Рева Н.В. О влиянии тонкого проводящего слоя на интегральные характеристики незаземленной индукционной петли / Н.В. Рева, Т.В. Руденко // Теоретичні та прикладні проблеми геоінформатики. — 2008. — С. 148–158.
- 8 Шуман В.Н. Современные электромагнитные зондирующие системы: состояние, тенденции развития, новые идеи и задачи / В.Н. Шуман // Геофизический журнал. — 2012. — 34. — № 4. — С. 282–291.
- 9 Шуман В.Н. Математические модели геоэлектрики / В.Н. Шуман, М.Г. Савин. — Киев: Наук. думка, 2011. — 240 с.

В.С. Портнов, Н.В. Рева, В.И. Онищук, Е.С. Ли

### Жұқа өткізгіш қабаттың үстінде орналасқан индукциялық ілгектің интегралдық сипаттамалары

Жердегі электромагниттік өрістердің жалпыланған заңдылықтарын кеңістіктік электр тізбектері ретінде талдау негізінде электромагниттік бұрғылаудың интегралды қағидасы қолданылатын электрметрияны дамытудағы мүмкін жаңа бағыттың негізгі қырларын айқындайтын жалпы нысан әзірленді. Гармоникалық токпен жұқа өткізгіш қабаты бар ілгектің динамикалық өзара әрекеттесу мәселесі шешілді. Нәтижесінде жиіліктің функциясы ретінде белсенді қарсыласудың және циклінің индуктивтілігінің динамикалық кадамдарын сипаттайтын аналитикалық қатынастар алынды. Оларға асимптоталық төмен және жоғары жиіліктер аралықтары бойынша асимптотикалық талдау жасалды, оның негізінде индукция циклінің интегралды сипаттамаларының эксперименталдық тәуелділіктерін интерпретациялау алгоритмдері әзірленді. Орындалған іргелі әзірлемелер зертханалық өлшеулердің эксперименттік деректеріне белсенді өткізгіштіктің, өткізгіш қабат үстінде және оның бетінде

орналасқан ілгектердің индуктивтілігінің өсу жиілігінің тәуелділігі тексерілді. Индукциялық циклдардың интегралдық көрсеткіштердің теориялық эзірлемелері және ақпараттылығы толық расталды.

*Кілт сөздер:* электрлік барлау, индукциялық цикл, белсенді қарсылық, бойлық өткізгіштік, өткізгіш қабат, магнит ағыны, жиілік, интеграциялық сипаттамалар, электромагниттік зондтау.

В.С. Портнов, Н.В. Рева, В.И. Онищук, Е.С. Ли

## Интегральные характеристики индукционной петли, расположенной над тонким проводящим слоем

На основе анализа обобщенных закономерностей электромагнитных полей в земле, как пространственных электрических цепей, в общей форме разработан интегральный принцип электромагнитных зондирований, который определяет собой основные контуры возможного нового направления развития прикладной электротехники. Решена задача о динамическом взаимодействии незаземленной петли, питаемой гармоническим током, с тонким проводящим слоем. В результате решения этой задачи получены аналитические соотношения, описывающие динамические приращения активного сопротивления и индуктивности петли в зависимости от частоты. Выполнен асимптотический анализ полученных соотношений в интервалах асимптотически низких и высоких частот, на основе которого разработаны алгоритмы интерпретации экспериментальных частотных зависимостей интегральных характеристик индукционной петли. Выполненные принципиальные разработки испытаны на экспериментальных данных лабораторных измерений частотных зависимостей приращения активного сопротивления и индуктивности петель, расположенных над проводящим слоем и на его поверхности. Получено полное подтверждение теоретических разработок и информативности интегральных параметров индукционных петель.

*Ключевые слова:* электроразведка, индукционная петля, активное сопротивление, индуктивность, продольная проводимость, проводящий слой, магнитный поток, частота, интегральные характеристики, электромагнитное зондирование.

### References

- 1 Vizhva, S.A., Reva, M.V., Onishchuk, I.I., & Onishchuk, V.I. (2014). *Elektrometriia. Posibnik iz navchalnoi heofizichnoi praktiki [Electrometry. Guidance on educational geophysical practice]*. Kiev: IPTs «Kievskii universitet» [in Ukrainian].
- 2 Kaufman, A.A., & Anderson, B.I. (2013). *Printsipy metodov nazemnoi i skvazhinnoi elektrorazvedki [Principles of ground and borehole electrical survey methods]*. Tver: Mezhdunarodnaia assotsiatsiia «AIS» [in Russian].
- 3 Kamenetsky, F.M., Stettler, E.H., & Trigubovich, G.M. (2010). *Transient Geo-Electromagnetics*. Munich: Ludwig-Maximilian-University of Munich.
- 4 Zhdanov, M.S. (2010). Electromagnetic geophysics: notes from the past and the road ahead, commercial application. *Geophysics*, 75, 49–66.
- 5 Svetov, B.S. (2008). *Osnovy heoelektriki [Fundamentals of geotectonics]*. Moscow: LKI [in Russian].
- 6 Kuzmenko, Ye.D., & Reva, M.V. (2014). *Teoriia polia [Field theory]*. Ivano-Frankivsk: IFNTUNG [in Ukrainian].
- 7 Reva, N.V., & Rudenko, T.V., (2008). O vliianii tonkogo provodiashcheho sloia na intehralnye kharakteristiki nezazemlennoi induktsionnoi petli [On the influence of a thin conducting layer on the integral characteristics of an ungrounded induction loop]. *Teoreticheskiye i prikladnyye problemy heoinformatiki – Theoretical and applied problems of geoinformatics*, 148–158 [in Russian].
- 8 Shuman, V.N. (2012). Sovremennyye elektromagnitnye zondirovushchie sistemy: sostoianie, tendentsii razvitiia, novye idei i zadachi [Modern electromagnetic sounding systems: state, development trends, new ideas and tasks]. *Heofizicheskii zhurnal – Geophysical Journal*, 34, 4, 282–291 [in Russian].
- 9 Shuman, V.N., & Savin, M.G. (2011). *Matematicheskiye modeli heoelektriki [Mathematical models of geoelectrics]*. Kiev: Naukova dumka [in Russian].