

DOI 10.31489/2020No2/116-122

UDC 538.971:621.039.64

DEUTERIUM TRAPPING IN TUNGSTEN IRRADIATED WITH DEUTERIUM PLASMA AT HIGH TEMPERATURES

Rakhadilov B.K.^{1,2*}, Skakov M.K.^{1,2}, Miniyazov A.ZH.², Zhurerova L.G.¹,
Nugumanova A.B.¹, Khassenov A.K.³, Karabekova D.Zh.³

¹Sarsen Amanzholov East-Kazakhstan State University, Ust-Kamenogorsk, Kazakhstan, [*rakhadilovb@mail.ru](mailto:rakhadilovb@mail.ru)

²National Nuclear Center of the Republic of Kazakhstan, Kurchatov, Kazakhstan

³E.A. Buketov Karaganda University, Karaganda, Kazakhstan

This work was attended to the study of the accumulation of deuterium, also to the investigation of the process of capture of deuterium in tungsten samples upon irradiation with a plasma beam. It was shown that after irradiation on the surface, a change in the surface is observed as the development of the relief as a result of non-uniform etching of the surface. The degree of change in the relief and structure of the surface layer of the irradiated samples depends on the irradiation temperature. The accumulation of deuterium tungsten under irradiation with deuterium plasma was studied. The conducted thermal desorption analysis of tungsten samples irradiated with deuterium plasma showed that the tungsten surface is saturated with deuterium. The data obtained by the method of emission spectrometry and thermal desorption spectrometry showed that the majority of the captured deuterium accumulates at a depth under the 7 μm.

Keywords: deuterium, irradiation, tungsten, a plasma beam.

Introduction

Tungsten is considered as a priority material for use in the diverter region of the ITER reactor due to such qualities as high melting point and high threshold energy of physical sputtering [1-4]. Today, one of the main requirements for materials in contact with thermonuclear plasma is the reduction of tritium content in these materials [5,6] fluxes of tritium and deuterium. It will be up to 1270 K [7]. It should be noted that the investigation of the tritium inventory. In addition, the study of the accumulation of hydrogen isotopes in tungsten materials when exposed to deuterium plasma is of particular interest for assessing the content of radioactive tritium in reactor elements during the operation of a fusion unit [8-10].

In connection with the foregoing, the purpose of this work is to study the accumulation of deuterium in tungsten materials upon irradiation with deuterium plasma.

1. Materials and methods

99.97% purity tungsten was selected as the object of study in accordance with the objectives. Samples in the form of a cylinder with a diameter of 10 mm and a height of 5 mm, were cut on the EDM machine. Before irradiation, the samples were ground and polished. Tungsten samples were irradiated with a deuterium plasma with an ion energy of 2 keV for 180 min. Samples were irradiated at temperatures of 1273 K (sample W-D-1) and 1773 K (sample W-D-2). During irradiation, the pressure in the chamber was 2×10^{-3} Torr.

Irradiation of samples with hydrogen plasma was carried out on a plasma-beam discharge setup that simulates plasma-surface interactions [11,12]. The plasma beam installation was developed to support the creation and operation of the Kazakhstan Material Tokamak for testing small-scale samples of KTM materials and equipment [13].

The study of the microstructure of tungsten samples before and after irradiation was performed using a JSM-6390 scanning electron microscope. The elemental analysis of the surface layer of irradiated tungsten was determined by the method of optical emission spectrometry on a Glow Discharge Spectrometer HR. The GD-Profilor emission glow discharge spectrometer is designed to determine the mass fraction of elements in solid samples with a pre-polished surface. The surface roughness of tungsten and the depth of craters formed after the study on an atomic emission spectrometer were determined on a Micro Measure 3D Station three-

dimensional contactless profilometer. The accumulation of deuterium in tungsten after irradiation with deuterium plasma was studied by thermal desorption spectrometry using an experimental VIKA unit [14–15]. Experimental installation VIKA allows to conduct experiments on the study of gas emission from various materials by the method of temperature-programmed desorption in the temperature range from 390 K to 1750 K with mass spectrometric recording of the emitted gases. The vacuum working chamber of the VIKA unit is shown in Fig. 1.

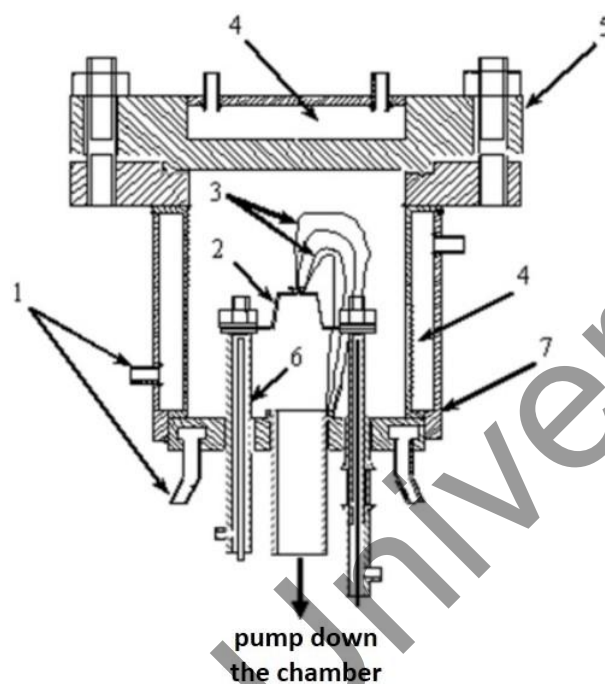

Fig.1. Vacuum working chamber installation VIKA

(1 - water cooling pipes; 2 - tantalum heater with crucible; 3 - thermocouples BP; 4 - water cooling circuit; 5 - cover of the vacuum chamber; 6 - current leads; 7 - vacuum chamber housing)

Method of research was concluded in: the cut out sample of irradiated tungsten was degreased, loaded into the crucible of the working chamber of the experimental setup [16]. After that, degassing of the working chamber walls was carried out at a temperature from 473 K to 500 K for two and a half hours with continuous pumping with a vacuum magnetic discharge pump NORD-250 and an EXT 75DX turbomolecular pump. Then the chamber walls were cooled to room temperature, and then an experiment on linear heating of the sample under investigation to a temperature of 1750 K with a heating rate of 15 K/min was carried out, with a constant pumping of the evolved gases from the volume of the working chamber and recording the partial gas pressures in the chamber. The release of H_2 and D_2 molecules was measured with an RGA-100 quadrupole mass spectrometer. During the experiments, the time dependences of changes in the partial pressures of gas in the vacuum chamber of the installation as a result of gas evolution from tungsten samples in the process of linear heating of the studied samples from 390 K to 1500 K were obtained.

2. Results and their discussion

The microstructure of the surface of tungsten before and after irradiation with deuterium plasma you can find in the Fig. 2. It can be seen from the figure that after irradiation, a change in the surface is observed as a development of the relief as a result of non-uniform etching of the surface. The resulting relief consists of chaotically located protrusions and depressions of various shapes. The development of the relief on the surface of tungsten under irradiation, apparently, is due to the sputtering of the surface. Thus, differently oriented crystals are characterized by different sputtering coefficients. In this case, irradiation at $T=1773$ K leads to the formation of small cracks.

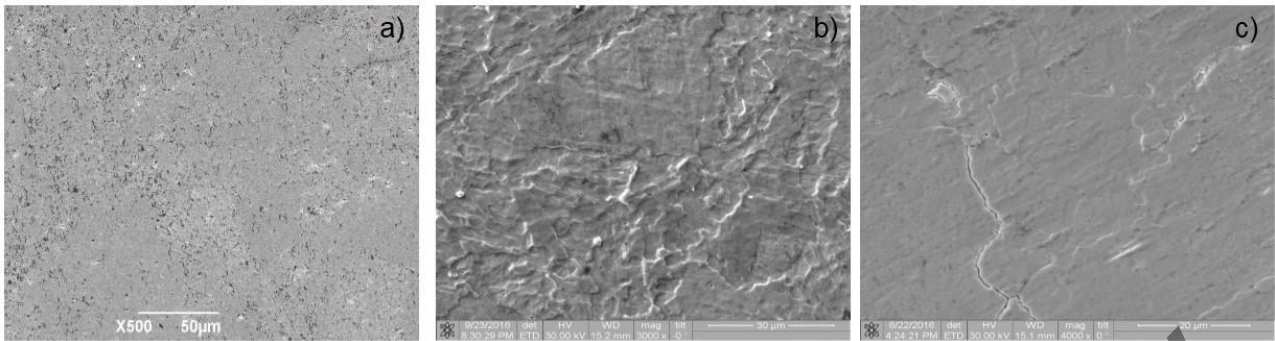

Fig. 2. The microstructure of the surface of tungsten before (a) and after irradiation with hydrogen plasma at T=1273 K (b) and T=1773 K (c)

The surface roughness was measured on an optical profilometer to assess the resulting of relief. It was determined that after irradiation with deuterium plasma the surface roughness changes. For irradiated samples at T=1273 K, the roughness parameter was $R_a=0.275 \mu\text{m}$, which is several times larger than the original sample. After irradiation at T=1773 K, the roughness was $R_a=0.453 \mu\text{m}$ (Fig.3a-c).

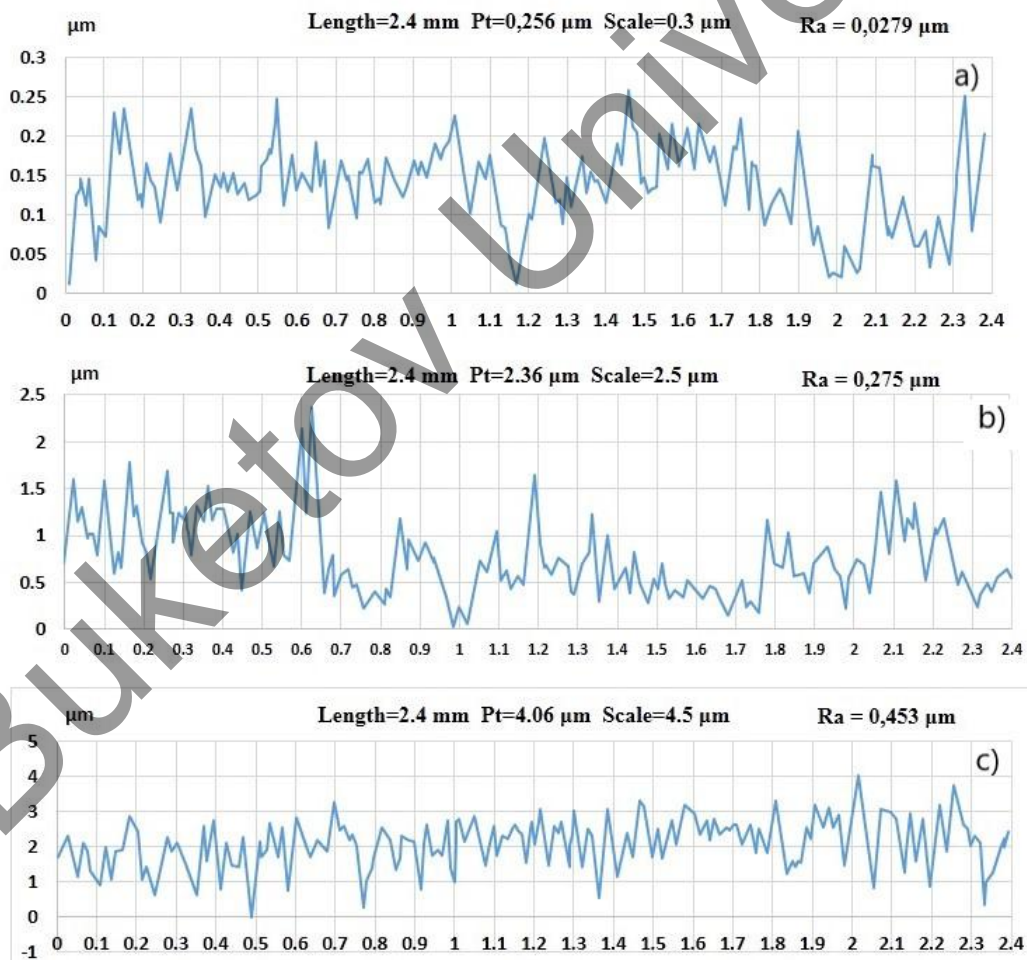

Fig. 3. The results of research on an optical profilometer

Research of the accumulation of gases in samples of tungsten under irradiation were carried out by the method of thermal desorption spectroscopy. Before conducting TDS experiments with the samples of tungsten under investigation, an experiment was carried out on gassing from an empty crucible when it was heated to a temperature of 1750 K at a rate of 15 K/min with a constant pumping out of the vacuum chamber. Fig. 4 shows the characteristic time dependences of the change in the partial pressures of gases in the volume of the working chamber when the crucible is heated.

The common view of gas evolution from an empty crucible presented in Fig. 4 may vary slightly in subsequent experiments, but the nature of gas evolution from an empty crucible remains the same. These dependences of gas evolution allow us to estimate the errors in the interpretation of data obtained during gas emission from the samples under study. From these graphs it can be seen that in the fourth mass (amount 4, corresponding to D_2), no peaks of gas evolution in the region up to 1600 K are observed in which deuterium is always present) from the elements of the design of the working chamber (growth in masses of amu 2 (H_2) and amu 3 (HD)).

Fig. 5 shows the time dependences of the change in the partial pressures of gases in the volume of the working chamber during the TDS experiments with the W-D-1 tungsten sample.

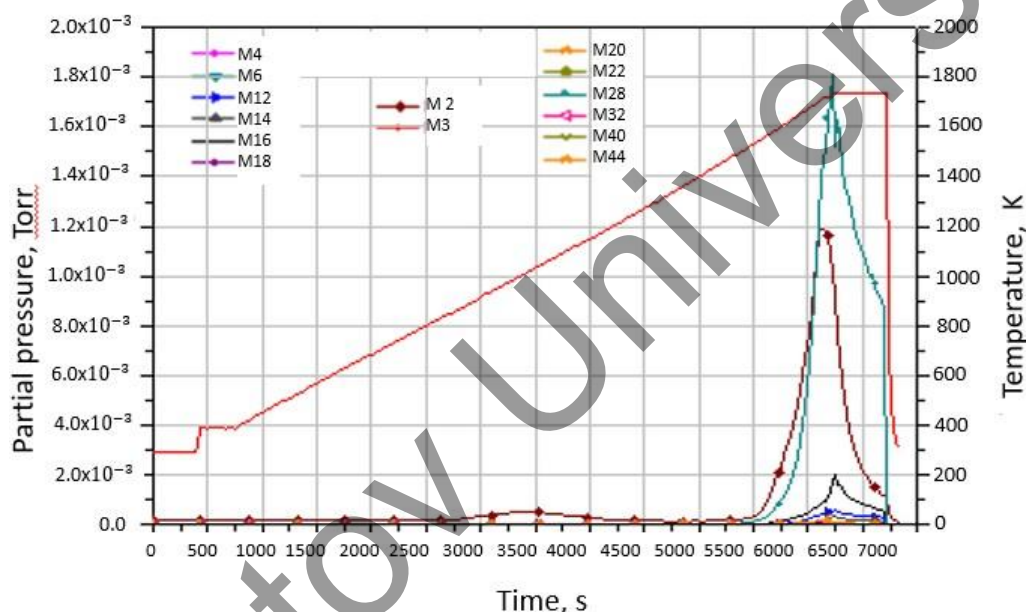

Fig. 4. Gas release from an empty crucible under heating at a speed of 15 K/min

It can be seen that with a temperature of 1500 K and above, a significant increase in the gas evolution curves for all hydrogen isotopes begins due to separation from the crucible. From the gas release graphs that was shown in Figure 4-5. This effect makes it difficult to interpret the results of TDS experiments with the test samples, therefore, further analysis of the results was carried out in the temperature range of samples from 300 K to 1500 K.

Figure 6 shows the temperature dependences of D_2 excretion (amount 4) when the empty crucible is heated, samples W-D-1 and W-D-1. On the graph of gas evolution D_2 (amount 4) there is a pronounced peak corresponding to the release of D_2 from sample WD-1 at a sample temperature of 1223 K. The sample temperature WD-1, at which the maximum deuterium emission occurs, corresponds to the sample temperature the WD-1 sample was saturated on a plasma beam installation (approximately 1223-1273 K). For the W-D-2 sample, it was not possible to fix a noticeable deuterium release due to the high background caused by the release of deuterium from the crucible and the design elements of the vacuum chamber during linear heating.

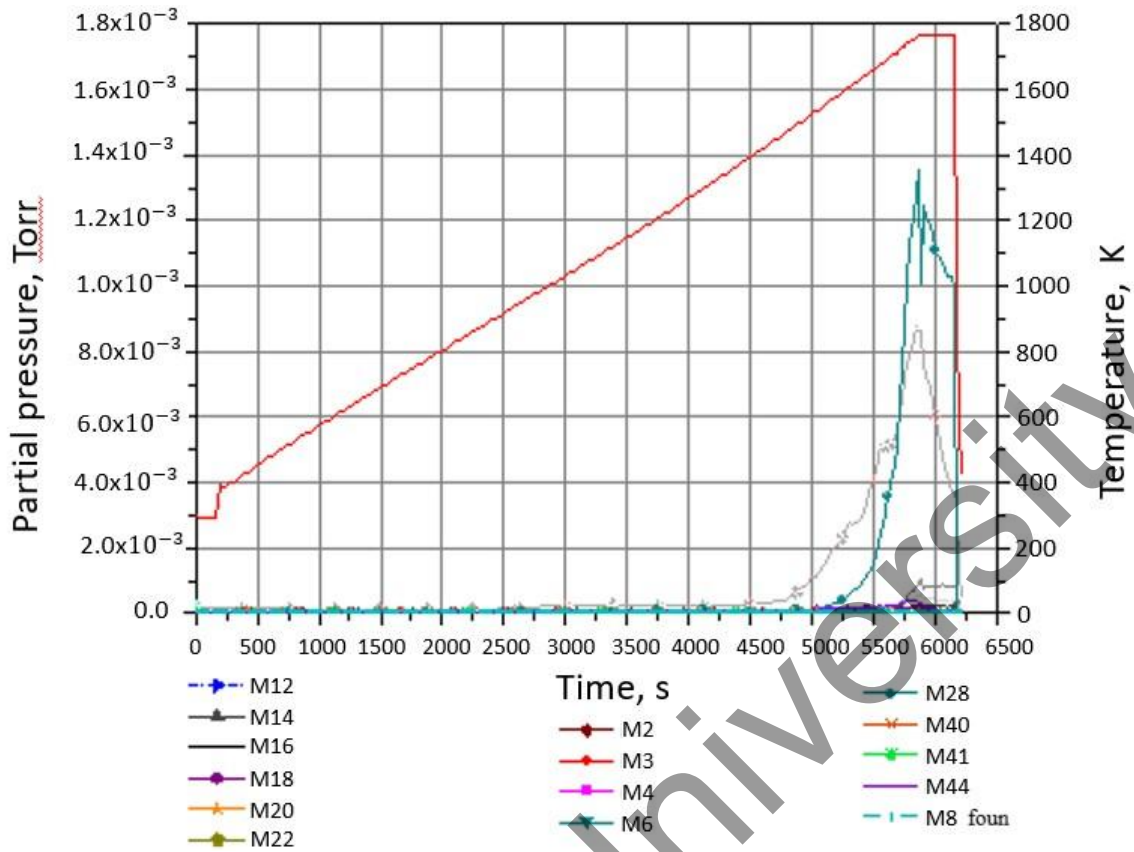

Fig. 5. Gas evolution from a sample of tungsten irradiated with deuterium plasma at $T=1273$ K ($m = 0.4572$ g; $V = 15$ K/min)

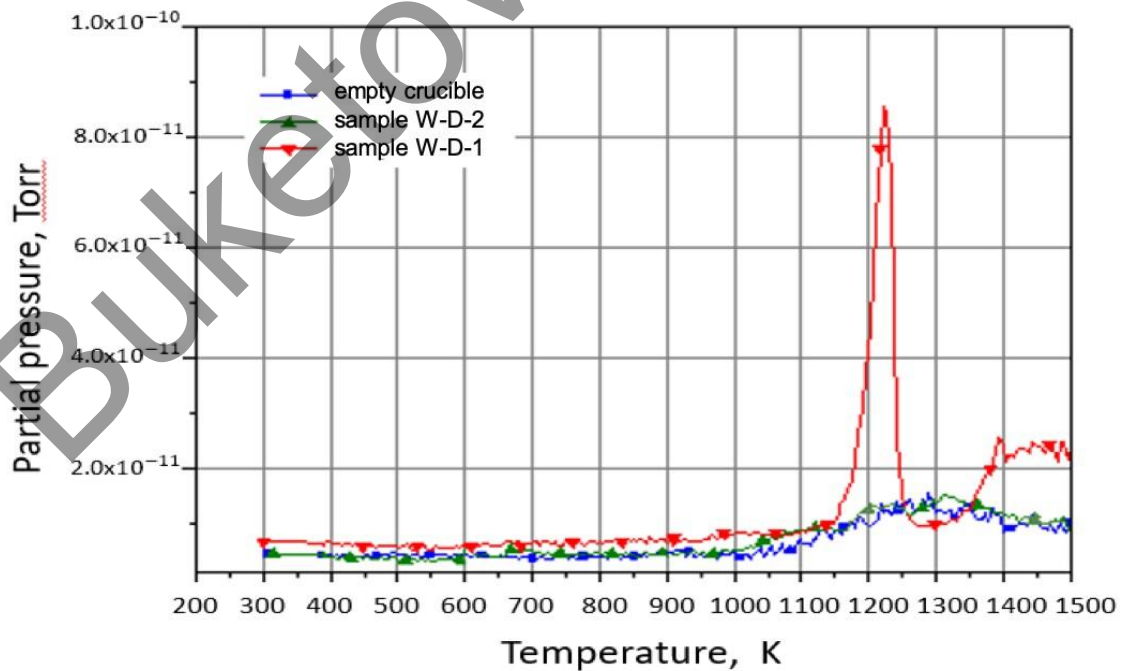

Fig. 6. Dependence of the change in the partial pressure D2 (a.e.m 4) on the sample temperature (crucible) in the working chamber of the experimental setup

Calculated from the obtained TDS dependences of the amount of released deuterium are given in Table 1. The total amount of released deuterium from the sample under study was $4,09 \cdot 10^{-11}$ mol despite the high irradiation temperature. The deuterium release peak had the form of a classical diffusion peak and is generally characteristic of the activation energy of deuterium diffusion in a sample with a value in the range from 130 kJ/mol to 200 kJ/mol.

Table 1 - The number of released deuterium from an empty crucible and the samples under study

Calculated data	Empty crucible	Sample, W-D-1
The amount of deuterium released to T=1500 K, mol	$2,84 \cdot 10^{-11}$	$6,93 \cdot 10^{-11}$
The amount of deuterium released to T=1500 K minus the background due to the heating of the crucible, mol	-	$4,09 \cdot 10^{-11}$
The amount of deuterium released to T=1500 K (referred to the mass of the samples)	-	$8,95 \cdot 10^{-11}$

Fig. 7 shows the results of a study of tungsten samples W-D-1 and W-D-2, obtained on an optical emission spectrometer. From Fig. 7 it can be seen that a noticeable accumulation of deuterium is observed only in the sample W-D-1. In this case, hydrogen (deuterium) accumulates in the surface layer of the W-D-1 sample to a depth of $\sim 7 \mu\text{m}$. At a depth of $0.5\text{-}3.0 \mu\text{m}$, a pronounced peak is observed, which is associated with the accumulation of deuterium mainly in the near-surface layer. This means that most of the traps in the volume of the material is not active and does not capture deuterium at the irradiation temperature (1273 K). The TDS method showed small amounts of trapped deuterium, since the samples were irradiated at high temperatures. And the method of optical emission spectroscopy, we obtained only the qualitative characteristics of the distribution of deuterium. The data of both methods are consistent with the nature of the temperature dependence. A noticeable accumulation of deuterium is observed at an irradiation temperature of 1273 K. At a temperature of 1773 K, the accumulation is significantly reduced, which is associated with the formation of traps with low binding energy with hydrogen.

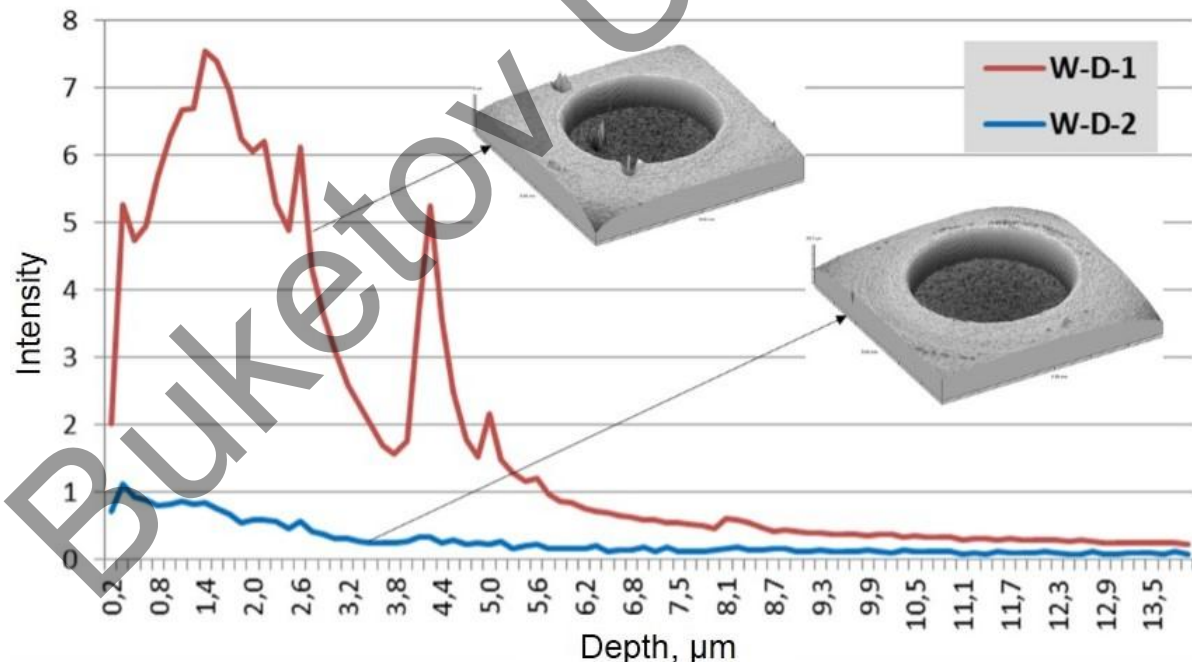

Fig.7. Results obtained on an optical emission spectrometer for W-D-1 tungsten samples

Conclusion

So, it has been established that, upon irradiation of tungsten, a change in the relief is observed as a result of non-uniform etching of the surface. The degree of change in the relief of the surface layer of the irradiated samples depends on the irradiation temperature and at $T=1773$ K small cracks form on the surface. Thermal desorption analysis showed that samples of tungsten irradiated with deuterium plasma at a temperature of 1273 K accumulate residual deuterium. In samples of tungsten irradiated with deuterium plasma at a temperature of 1773 K, no noticeable release of deuterium could be detected. Comparison of the data obtained by thermal desorption spectrometry and optical emission spectrometry suggests that the structure defect during irradiation leads to the accumulation of deuterium in the surface layer of tungsten, despite the high irradiation temperature.

Acknowledgement

The work has been implemented as part of the grant financing of scientific research by the Committee of Science of the Ministry of Education and Science of the Republic of Kazakhstan (BR05236748).

REFERENCES

- 1 Pitts R.A., Carpentier S., Escourbiac F., Hirai T., Komarov V., Lisgo S., et al. A full tungsten diverter for ITER: physics issues and design status. *J. Nucl. Mater.* 2013, Vol.438, pp. 48 – 56.
- 2 Philipps V. Tungsten as material for plasma-facing components in fusion devices. *Ibid.*, 2011, Vol. 415, pp. 2 – 9.
- 3 Shimada M., Pitts R., Loarte A., Campbell D.J., Sugihara M., Mukhovatov V., Kukushkin A., Chuyanov V. ITER research plan of plasma-wall interaction. *Ibid.*, 2009, Vol. 390 - 391, pp. 282 – 285.
- 4 Ueda Y., Coenen J.W., Temmerman G. De, Doerner R.P., Linke J., Philipps V., Tsitrone E. Research status and issues of tungsten plasma facing materials for ITER and beyond. *Fusion Eng. Des.*, 2014, Vol.89, pp. 901–906.
- 5 Federici G., Skinner C. H., Brooks J. N., et al. Plasma-material interactions in current tokamaks and their implications for next step fusion reactors. *Nucl. Fusion*, 2001, Vol.41, pp. 1967 – 2137.
- 6 Tobita K., Nishio S., Enoeda M., et al. Design study of fusion DEMO plant at JAERI. *Fusion Eng.*, 2006, Vol.81, pp. 1151 – 1158.
- 7 Gasparyan Yu. M., Golubeva A. V., Mayer M., Pisarev A. A., Roth J., J. Nucl. Mater. 2009, Vol.390-391, pp.606-609.
- 8 Zinkle S.J., Was G.S. Materials challenges in nuclear energy. *Acta Mater.*, 2013, Vol. 61, Iss.3, pp. 735 – 758.
- 9 Causey R.A., Doerner R., Fraser H., Kolasinski R.D., Smugeresky J., Umstadter K., Williams R. Defects in tungsten responsible for molecular hydrogen isotope retention after exposure to low energy plasmas. *J. Nucl. Mater.* 2009, Vol. 390-391, pp. 717 – 720.
- 10 Zhao M., Jacob W., Gao L., Manhard A., Dürbeck T., Zhou Z. Deuterium retention behavior of pure and Y2O3-doped tungsten investigated by nuclear reaction analysis and thermal desorption spectroscopy. *Nucl. Mater. Energy*, 2018, Vol. 15, pp. 32 – 42.
- 11 Tulenbergenov T., Skakov M., Kolodeshnikov A., Zuev V., Rakhadilov B., Sokolov I., Ganovichev D., Miniyazov A., Bukina O. Interaction between nitrogen plasma and tungsten. *Nuclear Materials and Energy*, 2017, Vol.13, pp. 63 – 67.
- 12 Rahadilov B.K., Skakov M.K., Tulenbergenov T.R. Tungsten surface erosion by hydrogen plasma irradiation. *Key Engineering Materials*, 2017, Vol. 736, pp. 46 – 51.
- 13 Tazhibayeva I., Kenzhin E., Shestakov V., Chikhray Y., Kulsartov T., Azizov E., Filatov O., Chernov V., J. Material science activities for fusion reactors in Kazakhstan. *Nucl. Mater.* 2009, Vol. 386 - 388, pp. 15 - 18.
- 14 Kulsartov T., Tazhibayeva I., Ponkratov Y., Gordienko Y., Zaurbekova Z., Baklanov V., Skakov M., Koyanbayev Y., Korovikov A., Chikray Y., Nesterov E. Investigation of hydrogen isotopes interaction with lithium CPS under reactor irradiation. *Fusion Eng. Des.*, 2017, Vol. 124, pp. 324 - 327.
- 15 Skakov M. K., Kurbanbekov Sh. R., Karakozov B. K., Bakhtibaev A. N. ssledovanie mikrostruktury i svoystv absorptsii-desorptsii vodoroda splavom na osnove titana. *Vestnik KazNANS*, 2017, Vol. 3-4, pp. 68 – 71. [in Russian].
- 16 Dyusambaev D.S., Shaimerdenov A.A., Chekushina L.V., Tazhibayeva I.L., Kulsartov T.V., Gordienko Yu.N., Zaurbekova J.A., Koyanbayev E.T., Kukushkin I.M., Kenzhin E.A., Mukanov A.O. Detritiation of different irradiated beryllium grades using high-temperature degassing method. *VAST. Ser. Thermonuclear fusion*, 2014, Vol.37(2), pp. 27-37. [in Russian].
- 17 Rahadilov B.K., Skakov M.K., Tulenbergenov T.R., Zhurerova L.G., Kurbanbekov Sh.R. Plasma installation for research of plasma-surface interaction. *Eurasian Physical Technical Journal*, 2019, Vol.16, No.2(32), pp. 36 - 42.